

EK, ADK & BOK Filter Drier Installation Instructions

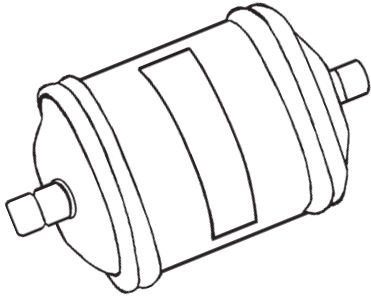

①

R-11
R-12
R-22
R-113
R-114
R-115
R-123
R-124
R-125
R-134a
R-401A

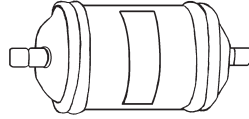

R-401B
R-402A
R-402B
R-404A
R-407A
R-407B
R-407C
R-410A
R-500
R-502
R-507

Refrigerant Compatibility

Compatibilidad con Refrigerantes

Compatibilidade do Refrigerante

Compatibilité du réfrigérant

冷媒適合性

냉매 호환성

冷媒兼容性

②

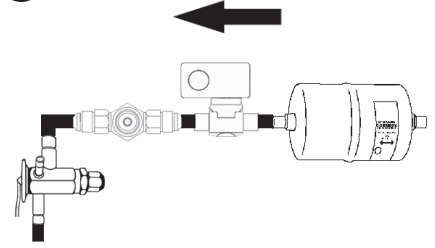

System Location

Localización en el Sistema

Localização do Sistema

Emplacement du système

取付位置

시스템 설치장소

系统中的位置

③

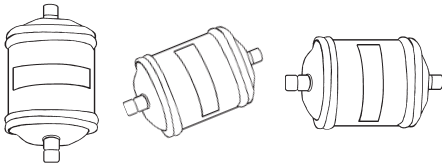

All Positions OK

Todas las Posiciones OK

Todas as Posições São Possíveis

Toute position OK

取付姿勢の制約無し

잘 설치 되었음

所有位置皆可

④

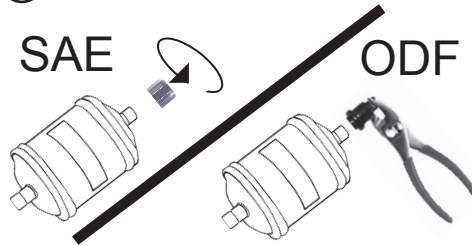

Remove Seals

Remueva los Empaques

Remova os Tampões

Enlever les capuchons

シールを取外す

봉인을 제거

拿去密封端盖

⑤

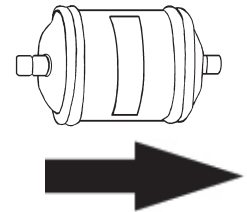

Flow Follows Arrow

El Flujo sigue la Flecha

Barra Indica Posição do Fluido

L'écoulement doit suivre la flèche

矢印方向に冷媒流

화살표방향으로 흐름

流向箭头

⑥

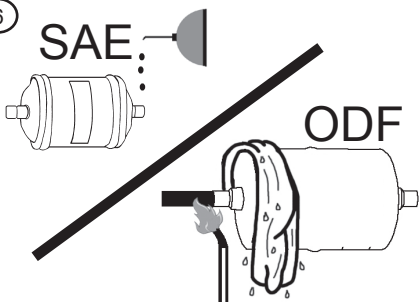

Installation Precautions

Precauciones de Instalación

Precações na Instalação

Précautions d'insatallation

取付時の注意

설치시 주의점

安装注意事项

⑦

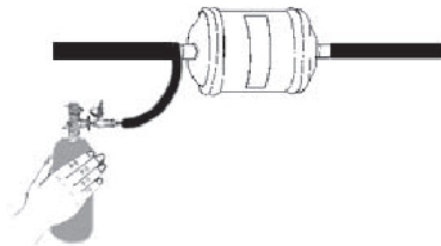

Pressurize And Check For Leaks

Presurize y Verifique si existen Fugas

Pressurize e Verifique Vazamentos

Pressuriser et vérifier pour les fuites

圧力をかけて漏れを検査

압력을 가하여 누설을 점검

增压及检查泄漏



Emerson Climate Technologies and the Emerson Climate Technologies logo are trademarks and service marks of Emerson Electric Co.
© 2004 Emerson Electric Co.